

## Solid State Relays

**V23100-S**  
**V23103-S**

### Features

- High switching rate and long life
- Switch-on at voltage zero crossing (relays with zero-point switch)
- Switch-off at current zero crossing
- Bounce-free switching as there are no moving parts
- No mechanical switching noise
- Low control power
- Insensitive to shock and vibration

### Versions

- With or without zero-point switch
- Load switching circuit: triac or 2 anti-parallel thyristors; corresponding to 1 make
- Termination: printed circuit or screw terminals
- Sealed by plastic encapsulation
- Dust-protected or immersion cleanable;  
immersion cleanable: protection class IP 67 in accordance with DIN 40050 (IEC 529)

### Approvals

 VDE    Marks of conformity ,  and 

 SEV    89,1 03278.04

 CSA    File LR 60229-6M

 UL    ML File E 85134 and ML File E 69913

Protective cover for V23100-S (types A2 and A8):

 UL    File E 69913

**Solid State Relays**

**SIEMENS/ POTTER/BRUMFIELD**

**Table 1 Ordering codes and characteristics**

Type		B3	B4 *)	B4
Ordering code		V23103-S2232-B302	V23103-S2032-B402	V23103-S2332-B402
Description	page	8.17	8.18	8.18
<b>Load switching circuit</b>				
Zero-point switch		yes	yes	no
Switching current (see derating curves)	$A_{rms}$	2	2.5	2.5
Switching voltage	$V_{rms}$	240	240	240
Switching voltage range	$V_{rms}$	24 ... 280	24 ... 280	24 ... 280
Max. repetitive peak blocking voltage	$V_S$	600	600	600
Frequency range	Hz	47 ... 63	47 ... 63	47 ... 63
Max. surge current, 1 cycle 50 Hz, non-repetitive, peak value	$A_S$	100	100	100
Min. switching current (holding current)	$mA_{rms}$	50	50	50
Max. off-state current (leakage current)	$mA_{rms}$	5	4.5	4.5
Max. on-state voltage (peak value) at max. switching current	$V_S$	1.6	1.6	1.6
Zero voltage	$V_S$	± 60	± 30	–
Critical rate of rise of off-state voltage (du/dt)	$V/\mu s$	200	200	200
Critical commutation rate of voltage rise	$V/\mu s$	5	5	5
Critical rate of rise of on-state current (di/dt)	$A/\mu s$	20	20	20
Peak load integral, 10 ms	$A^2s$	50	50	50
Max. operate time	ms	10	10	0.1
<b>Control circuit</b>				
Control voltage	V DC	3 ... 6	3 ... 30	3 ... 20
Pick-up voltage	V DC	≤ 3	≤ 3	≤ 3
Release voltage	V DC	> 1	> 1	> 1
Control current at max. control voltage	mA DC	< 18	< 30	< 30
Control circuit resistance	$\Omega$	330	1000	680
<b>General</b>				
Operating temperature range, typical	$^{\circ}C$	– 25...+ 80	– 25...+ 80	– 25...+ 80
Storage temperature range	$^{\circ}C$	– 40...+ 100	– 40...+ 100	– 40...+ 100
Test voltage	input – output	$kV_{rms}$	2.5	2.5
	input – case	$kV_{rms}$	–	–
	output – case	$kV_{rms}$	–	–
Insulation resistance	$\Omega$	$10^{10}$	$10^{10}$	$10^{10}$
Approvals		UL	SEV, UL	UL

\*) SCS – preferred standard type

1) Creepage distances and clearances > 8 mm, VDE 0806 and VDE 0750

2) Creepage distances and clearances > 8 mm, VDE 0806 and VDE 0700

## Solid State Relays

SIEMENS/ POTTER/BRUMFIELD

Type	B5	B5	A3 *)	B1 *)	B1 *)	B1 *)	B1
	V23103-S4032-B502 <sup>2)</sup>	V23103-S4332-B502	V23100-S0302-A303	V23103-S2033-B105	V23103-S2333-B105	V23103-S4033-B105 <sup>1)</sup>	V23103-S4333-B105
page	8.19	8.19	8.20	8.16	8.16	8.16	8.16

## Load switching circuit

	yes	no	yes	yes	no	yes	no
$A_{rms}$	2.5	2.5	3	5	5	5	5
$V_{rms}$	240	240	240	380	380	380	380
$V_{rms}$	24 ... 280	24 ... 280	24 ... 280	24 ... 480	24 ... 480	24 ... 480	24 ... 480
$V_S$	600	600	600	1200	1200	1200	1200
Hz	47 ... 63	47 ... 63	47 ... 63	47 ... 63	47 ... 63	47 ... 63	47 ... 63
$A_S$	100	100	50	100	100	100	100
$mA_{rms}$	50	50	50	50	50	50	50
$mA_{rms}$	4.5	4.5	5.5	4.5	4.5	4.5	4.5
$V_S$	1.6	1.6	1.6	1.6	1.6	1.6	1.6
$V_S$	± 30	± 30	± 30	± 65	–	± 65	–
$V/\mu s$	200	200	200	200	200	200	200
$V/\mu s$	5	5	5	–	–	–	–
$A/\mu s$	20	20	20	20	20	20	20
$A^2s$	50	50	18	50	50	50	50
ms	10	0.1	10	10	0.1	10	0.1

## Control circuit

V DC	3 ... 20	3 ... 20	3 ... 30	3 ... 30	3 ... 20	3 ... 20	3 ... 20
V DC	≤ 3	≤ 3	≤ 3	≤ 3	≤ 3	≤ 3	≤ 3
V DC	> 1	> 1	> 1	> 1	> 1	> 1	> 1
mA DC	< 30	< 30	< 20	< 30	< 30	< 20	< 30
Ω	680	680	1500	1000	680	1000	680

## General

°C	-25...+80	-25...+80	-25...+80	-25...+80	-25...+80	-25...+80	-25...+80
°C	-40...+100	-40...+100	-40...+100	-40...+100	-40...+100	-40...+100	-40...+100
$kV_{rms}$	3.75	2.5	2.5	2.5	2.5	4	4
$kV_{rms}$	–	–	–	–	–	–	–
$kV_{rms}$	–	–	–	–	–	–	–
Ω	10 <sup>10</sup>	10 <sup>10</sup>	10 <sup>10</sup>	10 <sup>10</sup>	10 <sup>10</sup>	10 <sup>10</sup>	10 <sup>10</sup>
	VDE, UL	UL	–	SEV, UL	UL	VDE, SEV, CSA	–

Table 1 Ordering codes and characteristics

Type		A2 *)	A2	A2 *)	
Ordering code		V23100-S0302-A210	V23100-S4032-A210 <sup>1)</sup>	V23100-S0302-A225	
Description	page	8.21	8.21	8.21	
<b>Load switching circuit</b>					
Zero-point switch		yes	yes	yes	
Switching current (see derating curves)	$A_{rms}$	10	10	25	
Switching voltage	$V_{rms}$	240	240	240	
Switching voltage range	$V_{rms}$	24 ... 280	24 ... 280	24 ... 280	
Max. repetitive peak blocking voltage	$V_S$	600	600	600	
Frequency range	Hz	47 ... 63	47 ... 63	47 ... 63	
Max. surge current, 1 cycle 50 Hz, non-repetitive, peak value	$A_S$	115	90	300	
Min. switching current (holding current)	$mA_{rms}$	50	50	50	
Max. off-state current (leakage current)	$mA_{rms}$	8	8	8	
Max. on-state voltage (peak value) at max. switching current	$V_S$	1.6	1.6	1.6	
Zero voltage	$V_S$	± 25	± 25	± 25	
Critical rate of rise of off-state voltage (du/dt)	$V/\mu s$	200	200	200	
Critical commutation rate of voltage rise	$V/\mu s$	5	200	5	
Critical rate of rise of on-state-current (di/dt)	$A/\mu s$	10	10	10	
Peak load integral, 10 ms	$A^2s$	66	40	450	
Max. operate time	ms	10	10	10	
<b>Control circuit</b>					
Control voltage	V DC	3 ... 30	3 ... 30	3 ... 30	
Pick-up voltage	V DC	≤ 3	≤ 3	≤ 3	
Release voltage	V DC	> 1	> 1	> 1	
Control current at max. control voltage	mA DC	< 20	< 30	< 20	
Control circuit resistance	$\Omega$	1500	1000	1500	
<b>General</b>					
Operating temperature range, typical	$^{\circ}C$	-25...+80	-25...+80	-25...+80	
Storage temperature range	$^{\circ}C$	-40...+100	-40...+100	-40...+100	
Test voltage	input – output	$kV_{rms}$	2.5	3.75	2.5
	input – case	$kV_{rms}$	2.5	2.5	2.5
	output – case	$kV_{rms}$	2.5	2.5	2.5
Insulation resistance	$\Omega$	$10^{10}$	$10^{10}$	$10^{10}$	
Approvals		–	VDE	–	
<b>Accessories</b>					
Protective cover; description on page 8.24		V23100-Z2008*)			

\*) SCS – preferred standard type

1) Creepage distances and clearances &gt; 8 mm, VDE 0806 and VDE 0750

## Solid State Relays

SIEMENS/ POTTER/BRUMFIELD

Type	A2	A8 *)	A8	A2 *)	A2	A8	A8
	V23100-S4032-A225 *)	V23100-S2034-A825	V23100-S2234-A825	V23100-S0302-A240	V23100-S4032-A240 *)	V23100-S2034-A840	V23100-S2234-A840
page	8.21	8.21	8.21	8.21	8.21	8.21	8.21

## Load switching circuit

	yes	yes	no	yes	yes	yes	no
$A_{rms}$	25	25	25	40	40	40	40
$V_{rms}$	240	415	415	240	240	415	415
$V_{rms}$	24 ... 280	24 ... 480	24 ... 480	24 ... 280	24 ... 280	24 ... 480	24 ... 480
$V_S$	600	1000	1000	600	600	1000	1000
Hz	47 ... 63	47 ... 63	47 ... 63	47 ... 63	47 ... 63	47 ... 63	47 ... 63
$A_S$	230	230	230	400	350	350	350
$mA_{rms}$	50	50	50	50	50	50	50
$mA_{rms}$	8	8	8	8	8	8	8
$V_S$	1.6	1.6	1.6	1.6	1.6	1.6	1.6
$V_S$	± 25	± 25	—	± 25	± 25	± 25	—
$V/\mu s$	200	200	200	200	200	200	200
$V/\mu s$	200	200	200	5	200	200	200
$A/\mu s$	10	10	10	10	10	10	10
$A^2s$	265	265	265	800	610	610	610
ms	10	10	0.1	10	10	10	0.1

## Control circuit

V DC	3 ... 30	3 ... 30	3 ... 30	3 ... 30	3 ... 30	3 ... 30	3 ... 30
V DC	≤ 3	≤ 3	≤ 3	≤ 3	≤ 3	≤ 3	≤ 3
V DC	> 1	> 1	> 1	> 1	> 1	> 1	> 1
mA DC	< 30	< 20	< 20	< 20	< 30	< 20	< 20
$\Omega$	1000	1500	1500	1500	1000	1500	1500

## General

°C	-25...+80	-25...+80	-25...+80	-25...+80	-25...+80	-25...+80	-25...+80
°C	-40...+100	-40...+100	-40...+100	-40...+100	-40...+100	-40...+100	-40...+100
$kV_{rms}$	3.75	2.5	2.5	2.5	3.75	2.5	2.5
$kV_{rms}$	2.5	2.5	2.5	2.5	2.5	2.5	2.5
$kV_{rms}$	2.5	2.5	2.5	2.5	2.5	2.5	2.5
$\Omega$	$10^{10}$	$10^{10}$	$10^{10}$	$10^{10}$	$10^{10}$	$10^{10}$	$10^{10}$
	VDE, UL	—	—	—	VDE, UL	—	—

## Accessories

Cover	V23100-Z2008*)
-------	----------------

**Solid State Relay Type B1**

SIEMENS/ POTTER/BRUMFIELD

**Type B1**

With or without zero-point switch

Immersion cleanable

For printed circuit mounting,  
pin arrangement suits 2.54 mm grid  
in acc. with DIN 40801

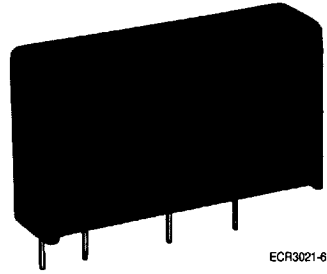

ECR3021-6

Illustration approx. original size  
Approx. weight 35 g

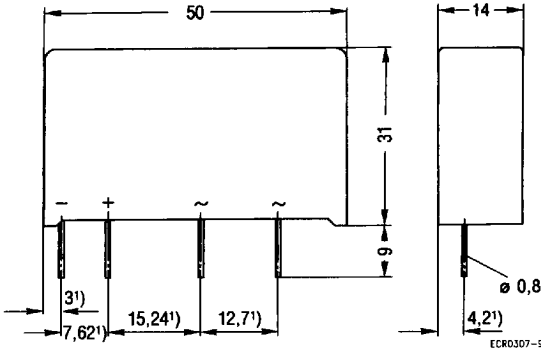

1) referred to wire outlet through sealing compound

**Derating curve**

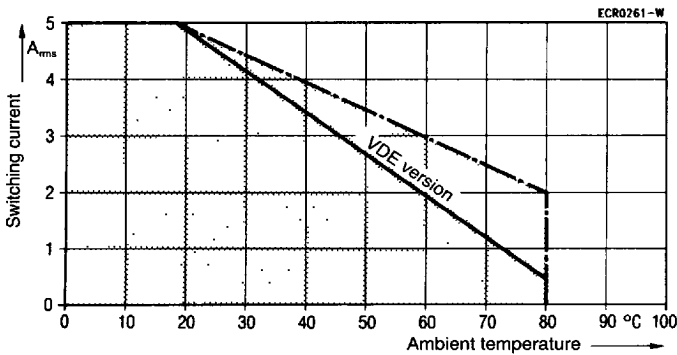

Switching current as a function of ambient temperature

# Solid State Relay Type B3

SIEMENS/ POTTER/BRUMFIELD

## Type B3

With zero-point switch

Immersion cleanable

For printed circuit mounting  
pin arrangement suits 2.54 mm grid  
in acc. with DIN 40801

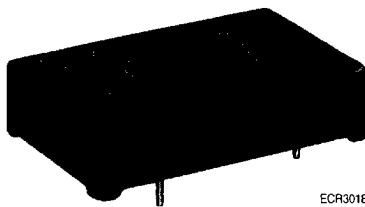

ECR3018-L

Illustration approx. original size  
Approx. weight 24 g

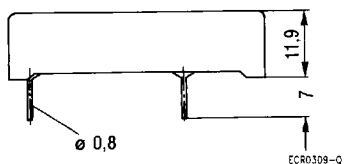
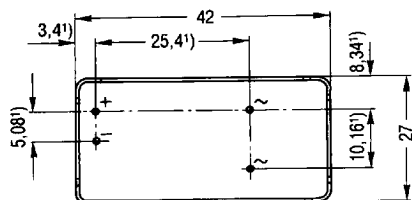

1) referred to wire outlet through sealing compound

## Derating curve

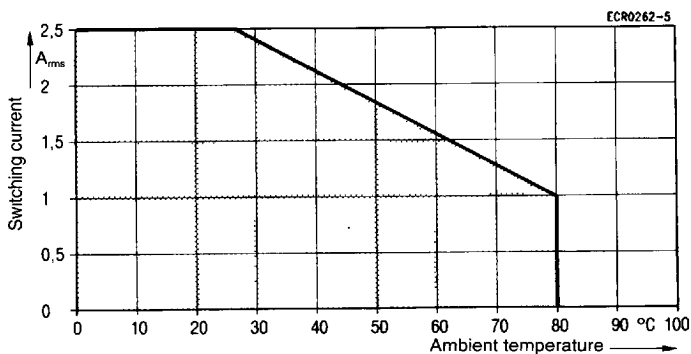

Switching current as a function of ambient temperature

# Solid State Relay Type B4

SIEMENS/ POTTER/BRUMFIELD

## Type B4

With or without zero-point switch

Immersion cleanable

For printed circuit mounting,  
pin arrangement suits 2.54 mm grid  
in acc. with DIN 40801

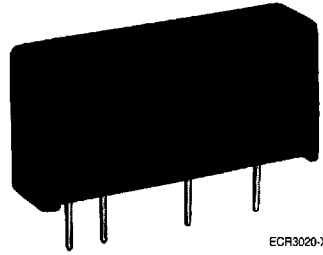

ECR3020-X

Illustration approx. original size  
Approx. weight 18.5 g

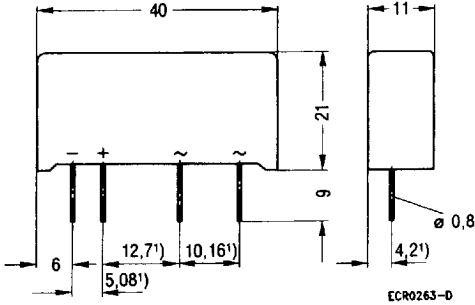

<sup>1)</sup> referred to wire outlet through sealing compound

## Derating curve

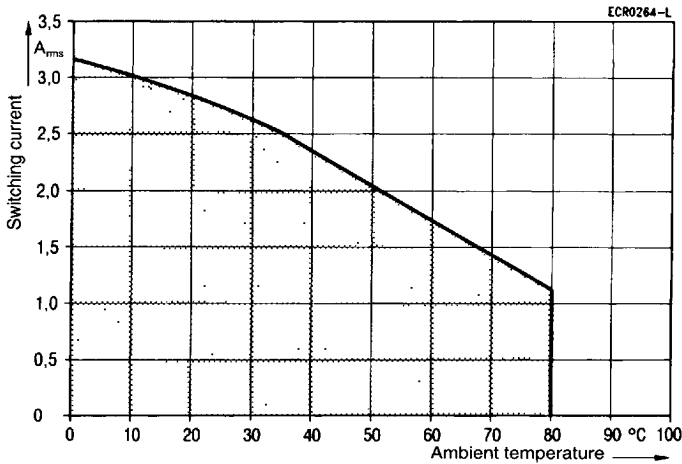

Switching current as a function of ambient temperature

8.18



# Solid State Relay Type B5

SIEMENS/ POTTER/BRUMFIELD

## Type B5

With or without zero-point switch

Immersion cleanable

For printed circuit mounting,  
pin arrangement suits 2.54 mm grid  
in acc. with DIN 40801

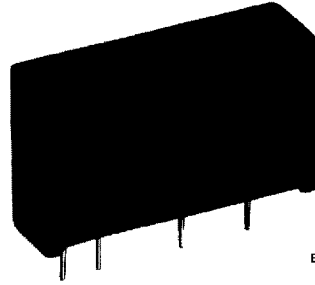

ECR3027 K

Illustration approx. original size  
Approx. weight 18.5 g

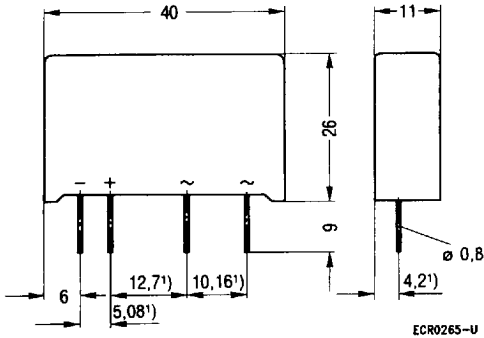

<sup>1)</sup> referred to wire outlet through sealing compound

## Derating curve

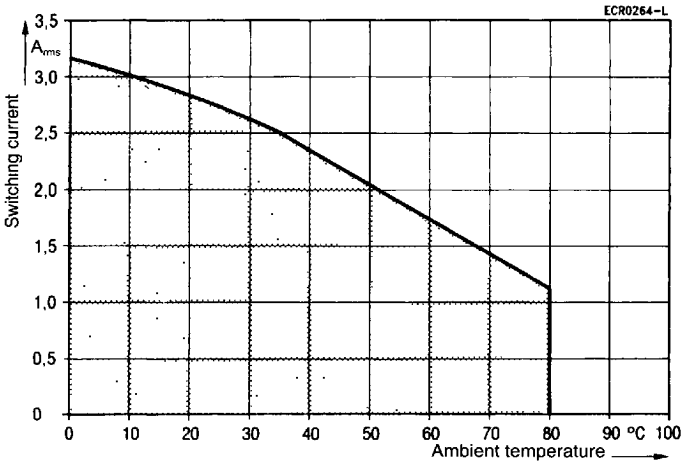

Switching current as a function of ambient temperature

# Solid State Relay Type A3

SIEMENS/ POTTER/BRUMFIELD

## Type A3

With zero-point switch

Immersion cleanable

For printed circuit mounting,  
pin arrangement suits 2.54 mm grid  
in acc. with DIN 40801

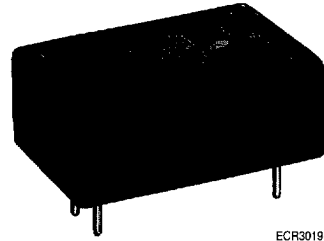

ECR3019-U

Illustration approx. original size  
Approx. weight 22 g

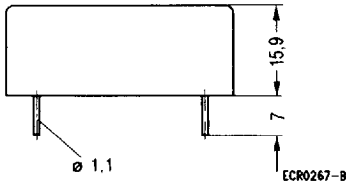
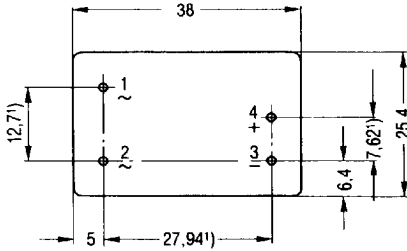

ECR0267-B

1) referred to wire outlet through sealing compound

## Derating curve

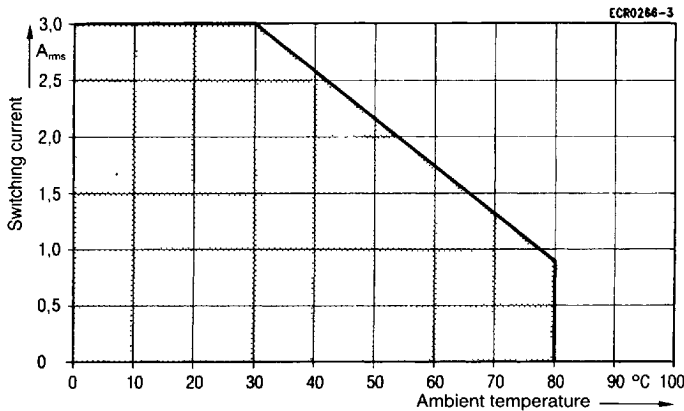

ECR0286-3

Switching current as a function of ambient temperature

8.20

# Solid State Relays Types A2 and A8

**Type A2** up to 280 V switching voltage  
**and**  
**Type A8** up to 480 V switching voltage

With zero-point switch

Dust-protected

For screw fixing

**Optionally with cover for shock-hazard protection**, see page 8.24

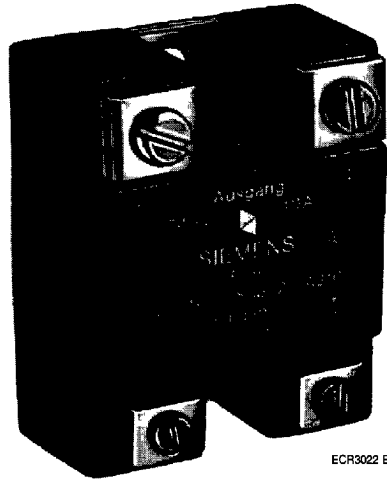

ECR3022 E

Illustration approx. original size  
 Approx. weight 115 g

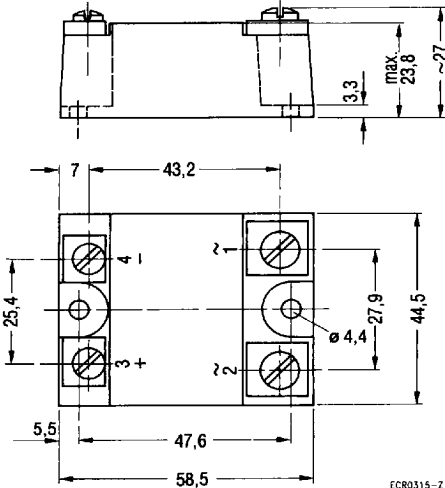

ECR0315-Z

### Mounting

The screw terminals are suitable for 2 single strand wires of up to 6 mm<sup>2</sup> (load switching side) and for wires of up to 4 mm<sup>2</sup> (control side) or cable clamps.

Bus bars and heat sinks should be constructed such that no additional tensile or compressive force is exerted on the relay. The supply cables must have a sufficiently large gauge to avoid heating up of the relay. This applies in particular when the relays are mounted directly in series with fuses.

### Derating curves 10 A

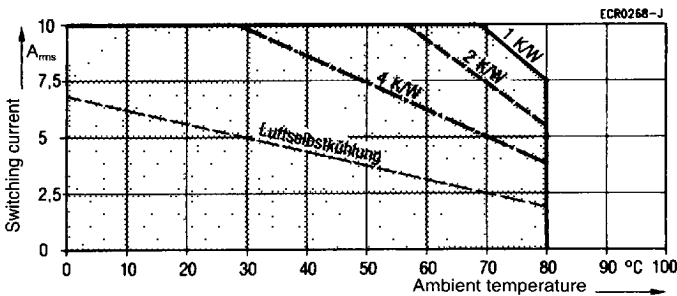

Switching current as a function of ambient temperature

To attain the stated current ratings it is necessary to mount the SSRs onto finned heat sinks or flat plates. The curves in the graph show the thermal resistance required of the heat sinks or plates. Apply a heat transfer compound when fitting the relay to the heat sink. At any rate check case temperature.

## Solid State Relays Types A2 and A8

25 A

SIEMENS/ POTTER/BRUMFIELD

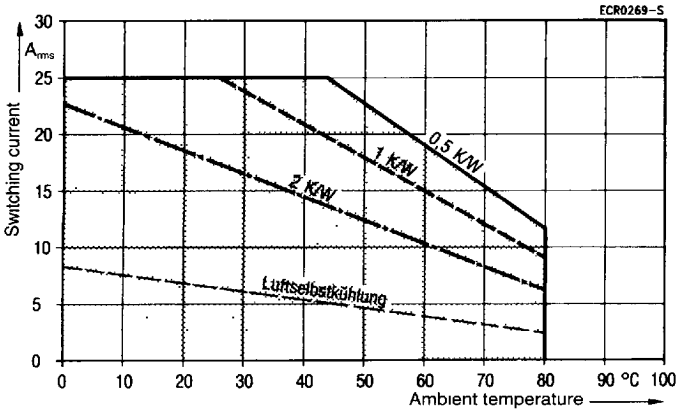

40 A

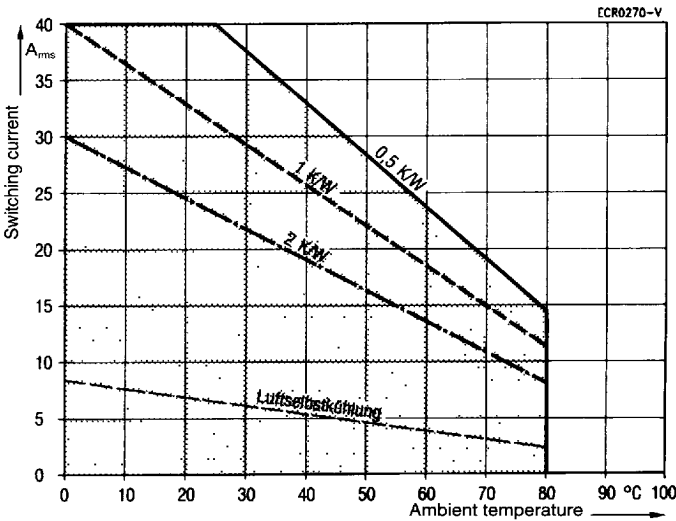

Switching current as a function of ambient temperature

To attain the stated current ratings it is necessary to mount the SSRs onto finned heat sinks or flat plates. The curves in the graphs show the thermal resistances required of the heat sinks or plates. Apply a heat transfer compound when fitting the relay to the heat sink. At any rate check case temperature.

### Solid State Relays Types A2 and A8

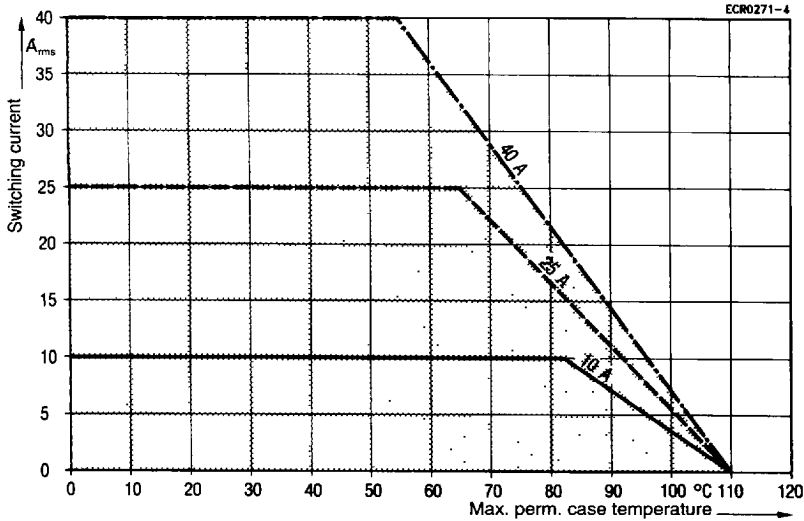

Switching current as a function of case temperature (measuring point at centre of base plate)

To attain the stated current ratings it is necessary to mount the SSRs onto finned heat sinks or flat plates. Apply a heat transfer compound when fitting the relay to the heat sink. At any rate check case temperature.

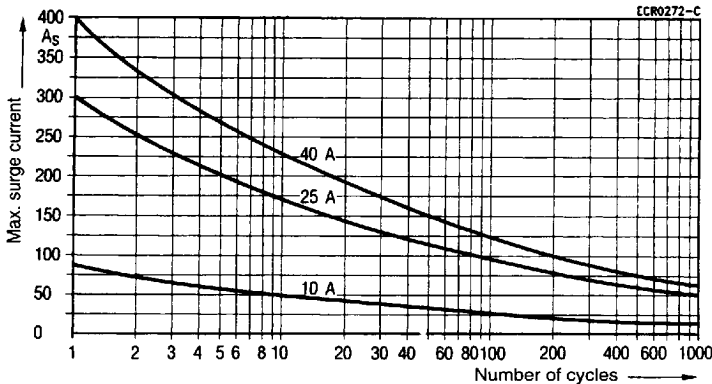

Max. surge current (peak value, non-repetitive) as a function of current duration (cycles)

Note: If loaded with the maximum surge current, the permitted junction temperature is exceeded. A temporary loss of blocking ability can be anticipated. It is necessary to disconnect from the mains. Switching on again is permitted only after cooling down to the crystal temperature permitted for normal operation. The maximum surge current may be utilized only occasionally, i.e. in the event of malfunction, and may be repeated at the earliest after a minimum interval of 5 seconds, but not periodically.

# Solid State Relays Types A2 and A8

Plastic protection cover

SIEMENS/ POTTER/BRUMFIELD

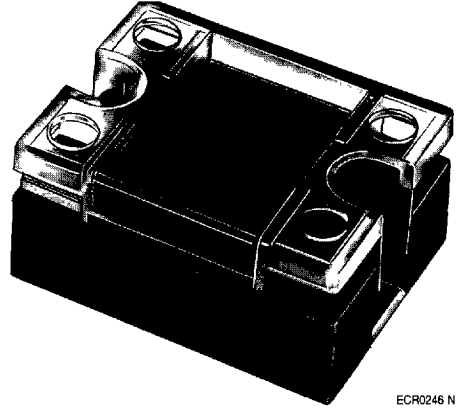

ECR0246 N

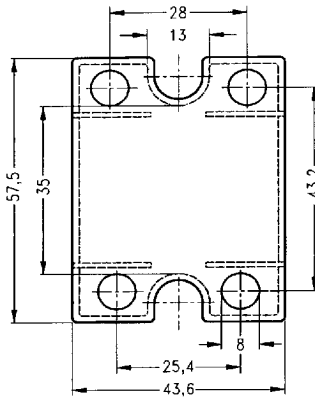
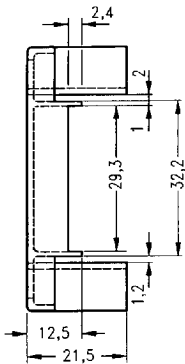

ECR0376-G

Protection against shock hazard from voltage carrying terminals; in unprotected equipment.

Approvals:



UL

File E 69913

## Ordering information

Ordering code

V23100-Z2008 \*)

\*) SCS – preferred standard type

8.24